

A - 900 [mm]  
 B - 1600 [mm]  
 G<sub>1</sub> - 20 [mm]  
 G<sub>2</sub> - 6 [mm]

C<sub>1</sub> - 210 [mm]  
 C<sub>2</sub> - 150 [mm]  
 D - 150 [mm]  
 L - 600 [mm]

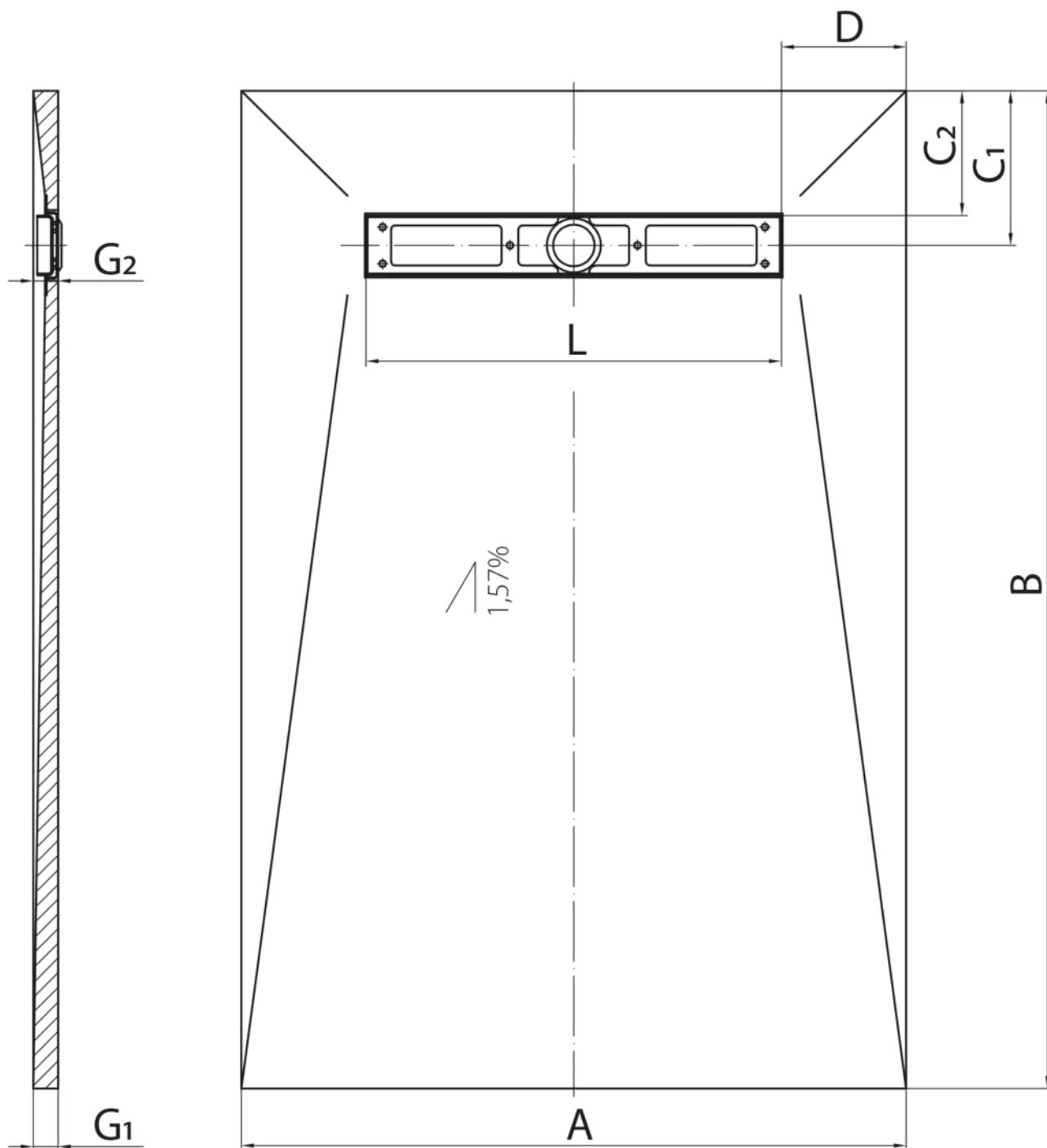

A - 900 [mm]  
 B - 1600 [mm]  
 $G_1$  - 28 [mm]  
 $G_2$  - 6 [mm]

$C_1$  - 210 [mm]  
 $C_2$  - 150 [mm]  
 D - 150 [mm]  
 L - 600 [mm]

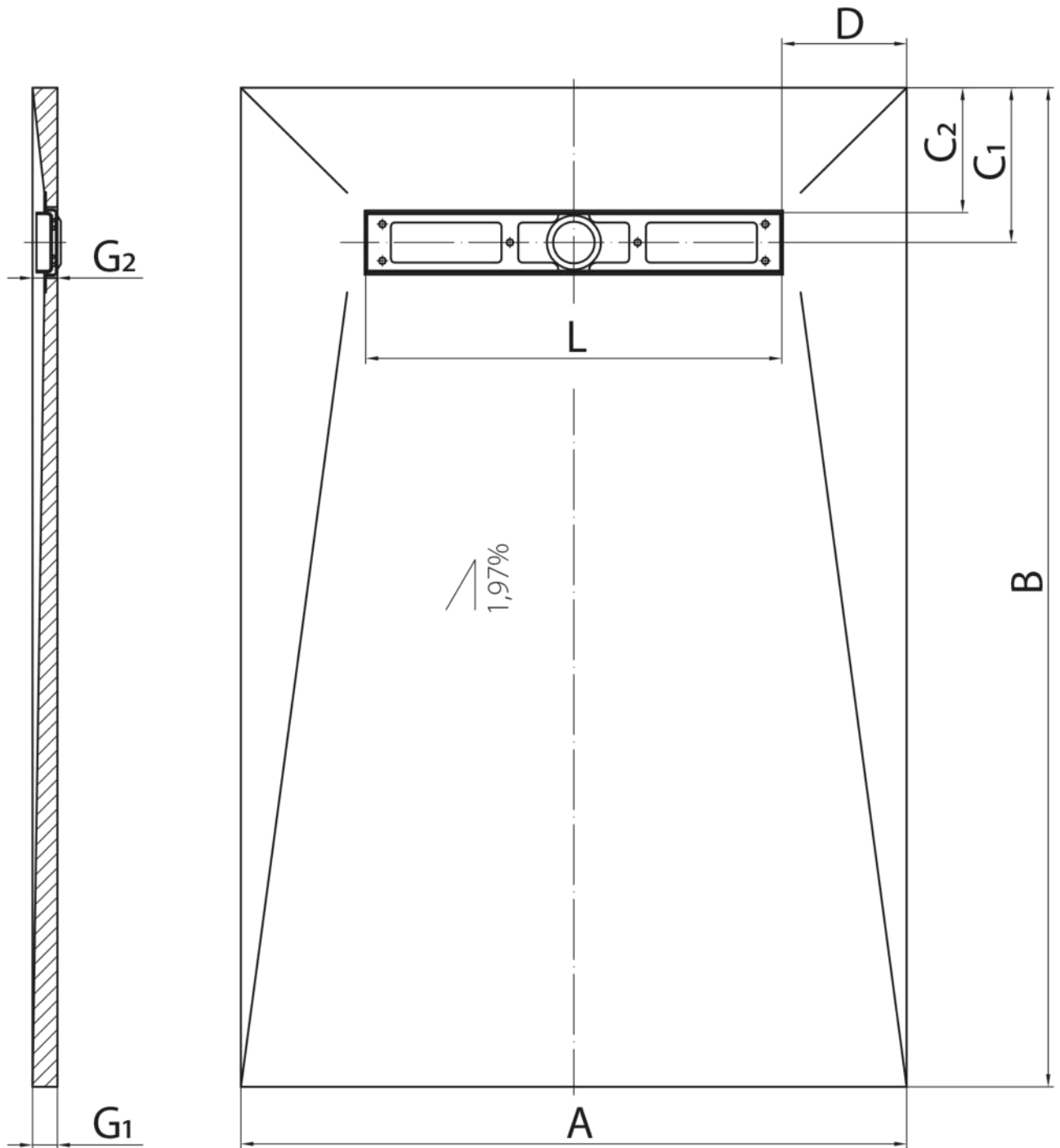

A - 900 [mm]  
 B - 1600 [mm]  
 G<sub>1</sub> - 35 [mm]  
 G<sub>2</sub> - 8 [mm]

C<sub>1</sub> - 210 [mm]  
 C<sub>2</sub> - 150 [mm]  
 D - 150 [mm]  
 L - 600 [mm]